

电路图：



目录仅供参考，实际规格依产品工程图为准 版本1.0

技术参数-UL (1059)

等级 Use Group	B	C	D
额定电压 Rated Voltage [V]	600	600	600
额定电流 Rated Current [A]	30	30	5
耐电压 Withstanding Voltage	2200V/1Min		
接线范围 Wire Range	24-10AWG		

技术参数-IEC(60947-7-1)

过电压类别 Overvoltage Category	III
污染等级 Contamination Class	3
额定电压 Rated Voltage	800V
额定电流 Rated Current	32A
额定冲击电压 Impulse withstand voltage	8KV

导线截面积 Conductor cross section

单芯 Solid	0.2-6.0mm ²
柔性导线 Flexible	0.2-4.0mm ²
柔性导线带冷压头 Flexible with ferrule	0.2-4.0mm ²

材料 Material

绝缘材料 Insulation Material	PA66
阻燃等级 Flame retardant rating	UL94V-0
导体材料 Conductor Material	Copper alloy
导体表面镀层 Plating of conductor surface	Sn plated

一般参数 Other Data

长/高/厚 Length/Height/Thickness [mm]	56/35.4/6.2
连接点数 Connection Points	2
剥线长度 Stripping Length [mm]	8-10
导轨类型 Type of rail	DIN 35
螺丝/扭矩 Screw/Torque(Max)[N.m]	/
工作温度 Operating temperature [°C]	-40~+105

尺寸图

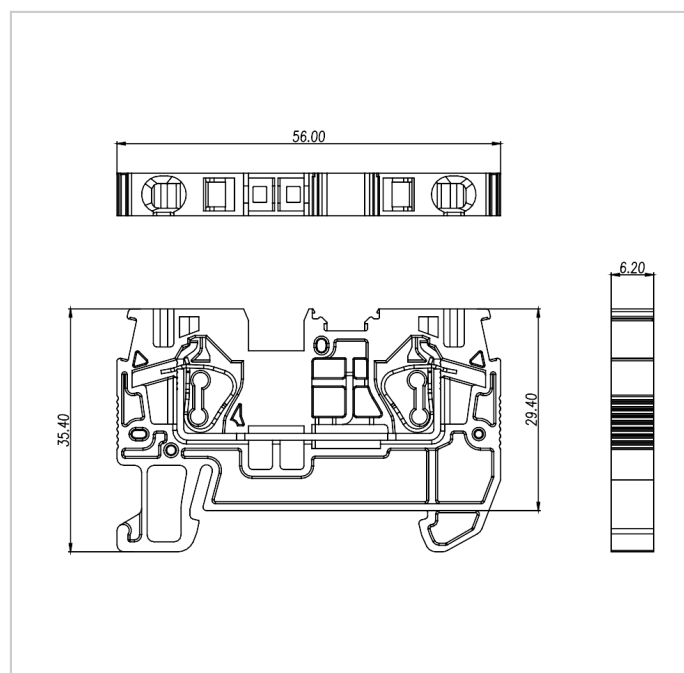

配件

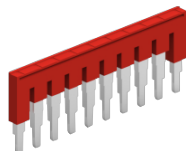

FUVA4-XX

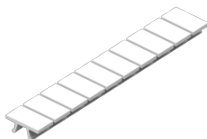

MUV4-10

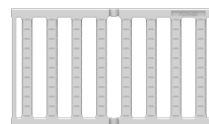

PUV4-80

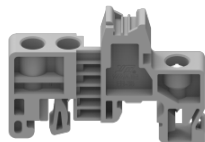

EB-35

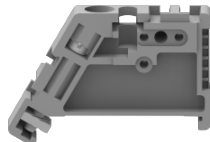

EW-35



DGL2-35x7.5A

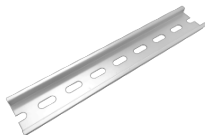

DGL2-35x7.5B

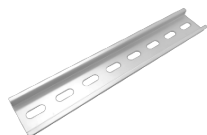

DGL2-35x7.5C



DGL2-35x7.5D



DUV4-102



DGS1-35x7.5W4.2x12



DGS1-35x7.5W5.2x15



DGS1-35x7.5W